

# Am2615/9615

## Dual Differential Line Receivers

### Distinctive Characteristics:

- Dual differential receiver (Am9615) pin-for-pin equivalent to the Fairchild 9615
- Dual differential receiver for single-ended data (Am2615)
- Single 5-volt supply
- High common-mode voltage range ( $\pm 15$  volts)

- Frequency response control, strobe, and internal terminating resistor
- Am2615 has fail safe capability
- Choice of uncommitted collector or active pull-up outputs
- 100% reliability assurance testing in compliance with MIL-STD-883

### FUNCTIONAL DESCRIPTION

The Am2615 and Am9615 are dual differential line receivers designed to receive digital data from transmission lines and operate over the military and industrial temperature ranges using a single 5 volt supply. The Am2615 can receive 3 volt single ended and the Am9615  $\pm 500$  mV differential data in the presence of high level ( $\pm 15$  V) common mode voltages and deliver undisturbed logic levels to the following DTL or TTL circuitry. The response time of each receiver and thereby immunity to AC noise can be controlled by an external capacitor. A strobe is provided for each receiver together with a  $130\Omega$  input terminating resistor. Each output has an uncommitted collector with an active pull-up network available on an adjacent pin.

The Am2615 is identical to the Am9615 except for the input offset (threshold) voltage. The Am2615 has an input threshold of  $\sim 1.5$  V compatible with DTL & TTL logic. The Am9615 has an input threshold of  $\sim 0$  V. The Am2615 can directly replace the Am9615 and give fail safe protection in differential systems where the input difference is  $> 2.0$  V.

### LOGIC DIAGRAM

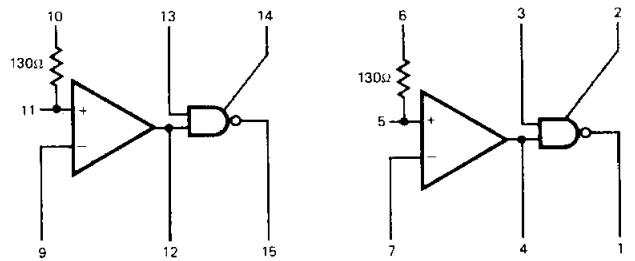

LIC-399

$V_{CC}$  = PIN 16  
GND = PIN 8

### CIRCUIT DIAGRAM

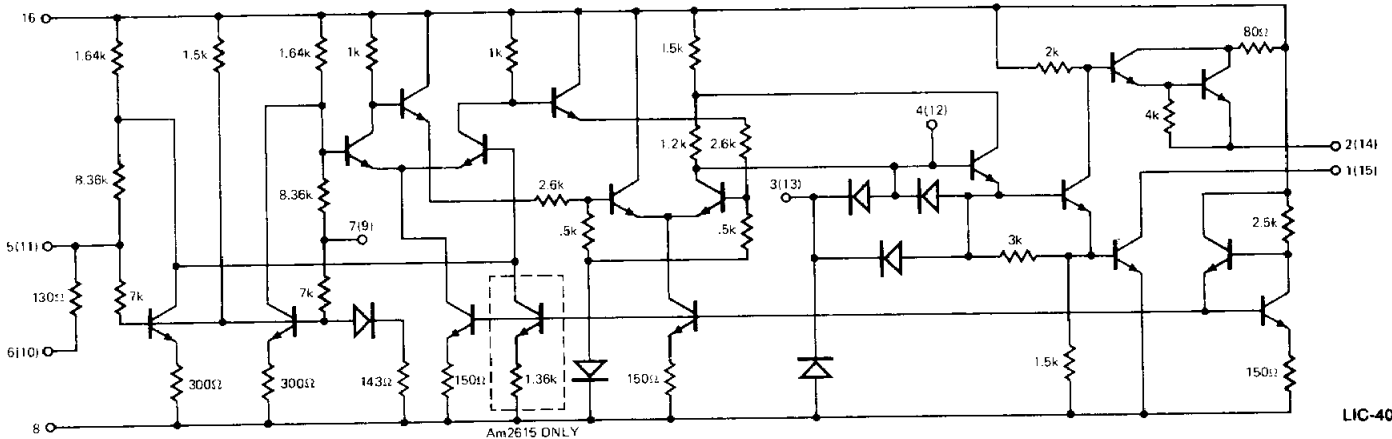

LIC-400

### ORDERING INFORMATION

Part Number	Package Type	Temperature Range	Order Number
Am2615	Hermetic DIP	$-55^{\circ}\text{C}$ to $+125^{\circ}\text{C}$	AM2615DM
	Flat Pak	$-55^{\circ}\text{C}$ to $+125^{\circ}\text{C}$	AM2615FM
	Dice	$-55^{\circ}\text{C}$ to $+125^{\circ}\text{C}$	AM2615XM
	Hermetic DIP	$0^{\circ}\text{C}$ to $+75^{\circ}\text{C}$	AM2615DC
	Molded DIP	$0^{\circ}\text{C}$ to $+75^{\circ}\text{C}$	AM2615PC
	Dice	$0^{\circ}\text{C}$ to $+75^{\circ}\text{C}$	AM2615XC
Am9615	Hermetic DIP	$-55^{\circ}\text{C}$ to $+125^{\circ}\text{C}$	9615DM
	Flat Pak	$-55^{\circ}\text{C}$ to $+125^{\circ}\text{C}$	9615FM
	Dice	$-55^{\circ}\text{C}$ to $+125^{\circ}\text{C}$	AM9615XM
	Hermetic DIP	$0^{\circ}\text{C}$ to $+75^{\circ}\text{C}$	9615DC
	Molded DIP	$0^{\circ}\text{C}$ to $+75^{\circ}\text{C}$	9615PC
	Dice	$0^{\circ}\text{C}$ to $+75^{\circ}\text{C}$	AM9615XC

### CONNECTION DIAGRAM Top View

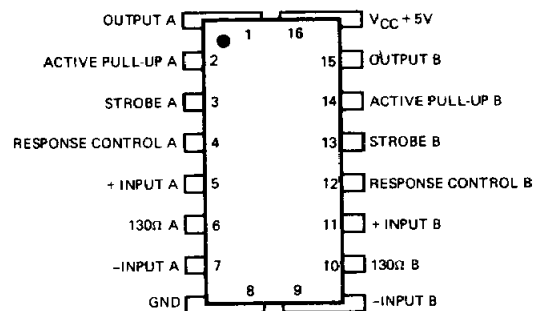

NOTE: PIN 1 is marked for orientation.

LIC-401

# Am2615/9615

## MAXIMUM RATINGS (Above which the useful life may be impaired)

Storage Temperature	-65°C to +150°C
Temperature (Ambient) Under Bias	-55°C to +125°C
Supply Voltage to Ground Potential (Pin 16 to Pin 8) Continuous	-0.5 V to +7 V
DC Voltage Applied to Outputs for HIGH Output State	-0.5 V to +13.2 V
DC Strobe Input Voltage	-0.5 V to +5.5 V
DC Data Input Voltage	-20 V to +20 V
Output Current, Into Outputs	30 mA
DC Input Current	maximum current is defined by DC Input Voltage

## Am2615 ELECTRICAL CHARACTERISTICS OVER OPERATING RANGE

Am2615XM	V <sub>CC</sub> = 4.5V to 5.5V	T <sub>A</sub> = -55°C to +125°C	(MIL grade)
Am2615XC	V <sub>CC</sub> = 4.75V to 5.25V	T <sub>A</sub> = 0°C to +75°C	(COM'L grade)

Parameters	Description	Test Conditions	LIMITS						Units		
			T <sub>A</sub> = Min		T <sub>A</sub> = 25°C		T <sub>A</sub> = Max				
			Min	Max	Min	Typ	Max	Min	Max		
V <sub>OH</sub>	Output HIGH Voltage	V <sub>CC</sub> = MIN, I <sub>OH</sub> = -5.0 mA V <sub>IN+</sub> = +0.8 V, V <sub>IN-</sub> = 0 V	2.4		2.4	3.2		2.4		Volts	
V <sub>OL</sub>	Output LOW Voltage	V <sub>CC</sub> = MAX I <sub>OH</sub> = 15.0 mA V <sub>IN+</sub> = +2.0 V, V <sub>IN-</sub> = 0 V	MIL grade	0.40		.18	0.40		0.40	Volts	
		COM'L grade	0.45		.25	0.45		0.45			
I <sub>CEX</sub>	Output Leakage Current	V <sub>CC</sub> = MIN V <sub>IN+</sub> = 0 V V <sub>IN-</sub> = 4.5 V	MIL grade	100			100		200	μA	
		V <sub>CEX</sub> = 12 V COM'L grade									
I <sub>SC</sub>	Output Short Circuit Current	V <sub>CC</sub> = MAX V <sub>OUT</sub> = 0 V V <sub>IN+</sub> = +0.8 V V <sub>IN-</sub> = 0 V	MIL grade	-15	-80	-15	-39	-80	-15	-80	mA
		COM'L grade	-14	-100	-14	-39	-100	-14	-100		
I <sub>IL</sub>	Input Load Current	V <sub>CC</sub> = MAX V <sub>IN</sub> = V <sub>OL MAX</sub> ; other input = V <sub>CC</sub>		-0.9		-0.49	-0.7		-0.7	mA	
I <sub>IL(ST)</sub>	Strobe Input Low Current	V <sub>CC</sub> = MAX V <sub>ST</sub> = V <sub>OL MAX</sub> V <sub>IN+</sub> = +2.0 V V <sub>IN-</sub> = 0 V		-2.4		-1.15	-2.4		-2.4	mA	
I <sub>IL(RC)</sub>	Response Control Input Load Current	V <sub>CC</sub> = MAX V <sub>RC</sub> = V <sub>OL MAX</sub> V <sub>IN+</sub> = +2.0 V V <sub>IN-</sub> = 0 V				-1.2	-3.4			mA	
V <sub>CM</sub>	Common Mode Voltage	V <sub>CC</sub> = 5.0 V V <sub>IN+</sub> - V <sub>IN-</sub> = 0.4 or 2.4 V		-15	+15	-15	±17.5	+15	-15	+15	V
I <sub>IH(ST)</sub>	Strobe Input HIGH Current	V <sub>CC</sub> = MIN V <sub>ST</sub> = 4.5 V V <sub>IN+</sub> = +0.8 V V <sub>IN-</sub> = 0 V	MIL grade					2.0		5.0	μA
		COM'L grade					5.0		10.0		
R <sub>IN</sub>	Input Resistor	V <sub>CC</sub> = 5.0 V V <sub>IN+</sub> = 0 V V <sub>RES</sub> = 1.0 V	MIL grade			77	130	167			Ω
		COM'L grade			74	130	179				
V <sub>TH</sub>	Differential Input Threshold Voltage	V <sub>CM</sub> = 0 V		+0.8	+2.0	+0.8	+1.5	+2.0	+0.8	+2.0	V
I <sub>CC</sub>	Power Supply Current	V <sub>CC</sub> = MAX V <sub>IN+</sub> = +2.0 V V <sub>IN-</sub> = 0 V	MIL grade	50		28.7	50		50		mA
		COM'L grade	50		28.7	50		50			

## Switching Characteristics (T<sub>A</sub> = 25°C)

Parameters	Test Conditions	Am2615XM			Am2615XC			Units	
		Min	Typ	Max	Min	Typ	Max		
t <sub>pd+</sub> Turn Off Delay	R <sub>L</sub> = 3.9 kΩ	V <sub>CC</sub> = 5.0 V, C <sub>L</sub> = 30 pF Refer to figure 4	30		50	30		75	ns
t <sub>pd-</sub> Turn On Delay	R <sub>L</sub> = 390 Ω		30		50	30		75	
t <sub>pd+</sub> Turn Off Delay	Strobe to Output	R <sub>L</sub> = 3.9 kΩ, C <sub>L</sub> = 30 pF	7		12	7		15	ns
t <sub>pd-</sub> Turn On Delay	Strobe to Output	R <sub>L</sub> = 390 Ω	10		15	10		20	

## Am9615 ELECTRICAL CHARACTERISTICS OVER OPERATING RANGE

Am9615XM  $V_{CC} = 4.5V$  to  $5.5V$   $T_A = -55^{\circ}C$  to  $+125^{\circ}C$  (MIL grade)  
 Am9615XC  $V_{CC} = 4.75V$  to  $5.25V$   $T_A = 0^{\circ}C$  to  $+75^{\circ}C$  (COM'L grade)

www.DataSheet4U.com

Parameters	Description	Test Conditions	LIMITS						Units		
			$T_A = \text{Min}$		$T_A = 25^{\circ}C$			$T_A = \text{Max}$			
			Min	Max	Min	Typ	Max	Min	Max		
$V_{OH}$	Output HIGH Voltage	$V_{CC} = \text{MIN}$ , $I_{OH} = -5.0 \text{ mA}$ $V_{IN+} = -0.5 \text{ V}$ , $V_{IN-} = 0 \text{ V}$	2.4		2.4	3.2		2.4		Volts	
$V_{OL}$	Output LOW Voltage	$V_{CC} = \text{MAX}$ $I_{OH} = 15.0 \text{ mA}$ $V_{IN+} = +0.5 \text{ V}$ , $V_{IN-} = 0$	MIL grade	0.40		.18	0.40		0.40	Volts	
			COM'L grade	0.45		.25	0.45		0.45		
$I_{CEX}$	Output Leakage Current	$V_{CC} = \text{MIN}$ $V_{IN+} = 0 \text{ V}$ $V_{IN-} = V_{CC}$	MIL grade	100			100		200	$\mu\text{A}$	
			COM'L grade		$V_{CEX} = 12 \text{ V}$						$V_{CEX} = 5.25 \text{ V}$
$I_{SC}$	Output Short Circuit Current	$V_{CC} = \text{MAX}$ $V_{OUT} = 0 \text{ V}$ $V_{IN+} = -0.5 \text{ V}$ $V_{IN-} = 0 \text{ V}$	MIL grade	-15	-80	-15	-39	-80	-15	-80	mA
			COM'L grade	-14	-100	-14	-39	-100	-14	-100	
$I_{IL}$	Input Load Current	$V_{CC} = \text{MAX}$ $V_{IN} = V_{OL \text{ MAX}}$ , other input = $V_{CC}$		-0.9		-0.49	-0.7		-0.7	mA	
$I_{IL(ST)}$	Strobe Input Low Current	$V_{CC} = \text{MAX}$ $V_{IN+} = +0.5 \text{ V}$ $V_{ST} = V_{OL \text{ MAX}}$ $V_{IN-} = 0 \text{ V}$		-2.4		-1.15	-2.4		-2.4	mA	
$I_{IL(RC)}$	Response Control Input Load Current	$V_{CC} = \text{MAX}$ $V_{IN+} = +0.5 \text{ V}$ $V_{RC} = V_{OL \text{ MAX}}$ $V_{IN-} = 0 \text{ V}$				-1.2	-3.4			mA	
$V_{CM}$	Common Mode Voltage	$V_{CC} = 5.0 \text{ V}$ $V_{IN+} - V_{IN-} = \pm 2.0 \text{ V}$	-15	+15	-15	$\pm 17.5$	+15	-15	+15	V	
$I_{IH(ST)}$	Strobe Input HIGH Current	$V_{CC} = \text{MIN}$ $V_{ST} = 4.5 \text{ V}$ $V_{IN+} = -0.5 \text{ V}$ $V_{IN-} = 0 \text{ V}$	MIL grade					2.0	5.0	$\mu\text{A}$	
			COM'L grade					5.0	10.0		
$R_{IN}$	Input Resistor	$V_{CC} = 5.0 \text{ V}$ $V_{IN+} = 0 \text{ V}$ $V_{RES} = 1.0 \text{ V}$	MIL grade			77	130	167		$\Omega$	
			COM'L grade			74	130	179			
$V_{TH}$	Differential Input Threshold Voltage	$V_{CM} = 0 \text{ V}$	-0.5	+0.5	-0.5	$\pm 0.02$	+0.5	-0.5	+0.5	V	
$I_{CC}$	Power Supply Current	$V_{CC} = \text{MAX}$ $V_{IN+} = +0.5 \text{ V}$ $V_{IN-} = 0 \text{ V}$	MIL grade	50		28.7	50		50	mA	
			COM'L grade	50		28.7	50		50		

Switching Characteristics ( $T_A = 25^{\circ}C$ )

Parameters	Test Conditions	Am9615XM			Am9615XC			Units
		Min	Typ	Max	Min	Typ	Max	
$t_{pd+}$ Turn Off Delay	$R_L = 3.9 \text{ k}\Omega$	$V_{CC} = 5.0 \text{ V}$ , $C_L = 30 \text{ pF}$ Refer to figure 4	30	50		30	75	ns
$t_{pd-}$ Turn On Delay	$R_L = 390 \Omega$		30	50		30	75	
$t_{pd+}$ Turn Off Delay	Strobe to Output	$R_L = 3.9 \text{ k}\Omega$ , $C_L = 30 \text{ pF}$	7	12		7	15	ns
$t_{pd-}$ Turn On Delay	Strobe to Output	$R_L = 390 \Omega$	10	15		10	20	

D. C. CHARACTERISTICS

Output Low Voltage Versus Output Low Current

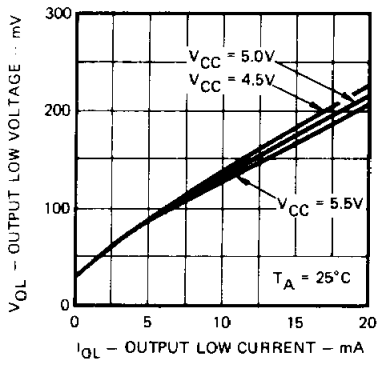

Output High Voltage Versus Output High Current

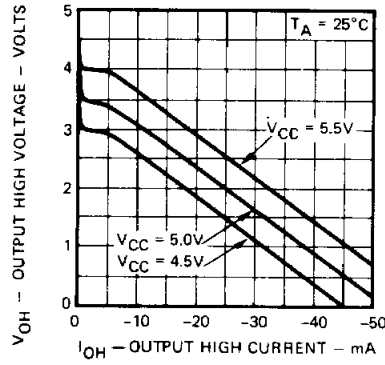

Output Voltage Versus Ambient Temperature

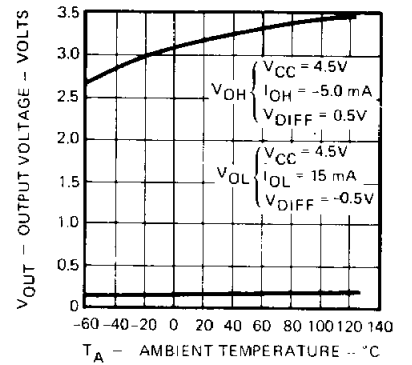

Strobe Input-Output Transfer Characteristic Versus VCC

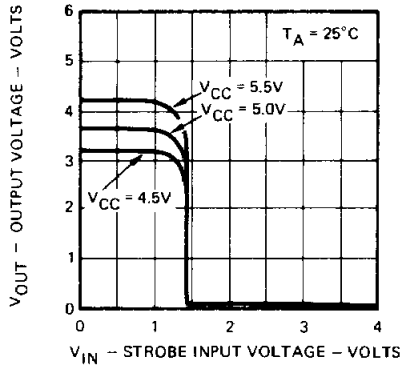

Strobe Input-Output Transfer Characteristic Versus Ambient Temperature

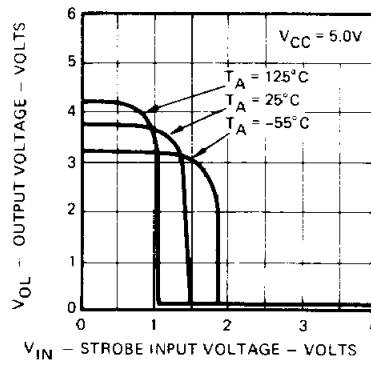

Output Voltage Versus Common Mode Voltage (Am9615)

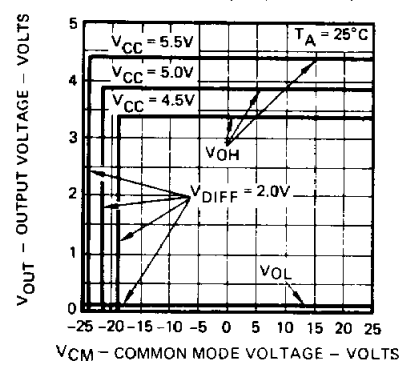

Input Current Versus Input Voltage

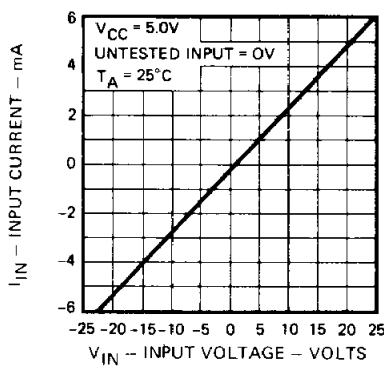

Power Supply Current Versus Power Supply Voltage

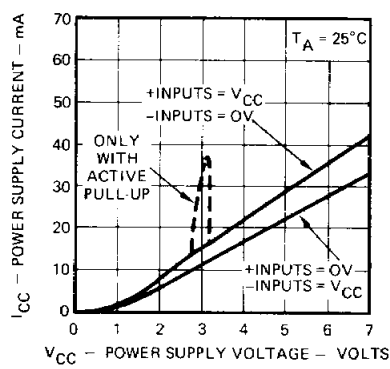

Power Supply Current Versus Ambient Temperature

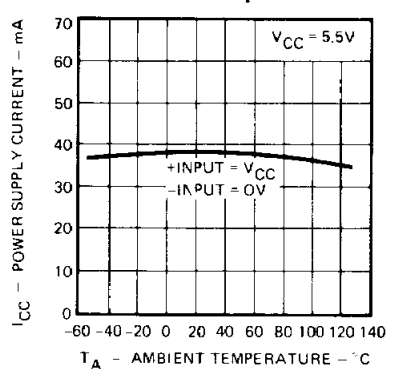

Switching Time Versus Ambient Temperature

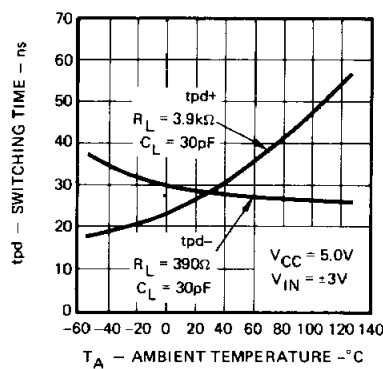

THRESHOLD CHARACTERISTICS

Am2615

Am9615

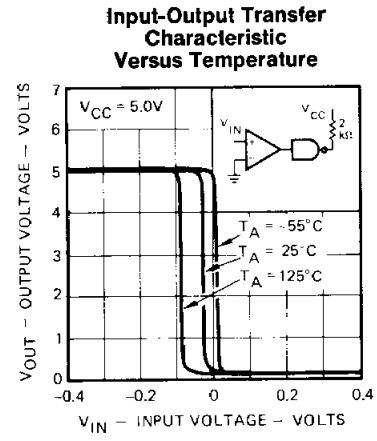
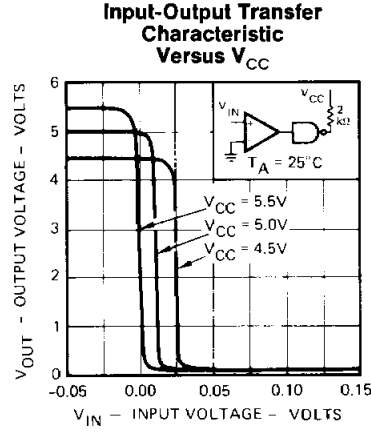
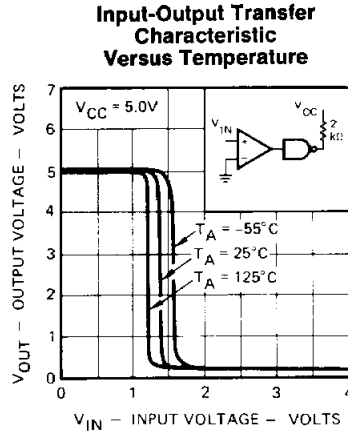
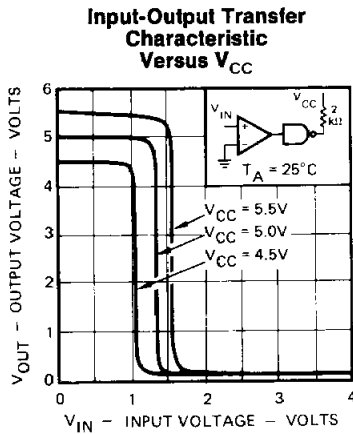

LIC-403

SWITCHING TIME TEST CIRCUIT & WAVEFORMS

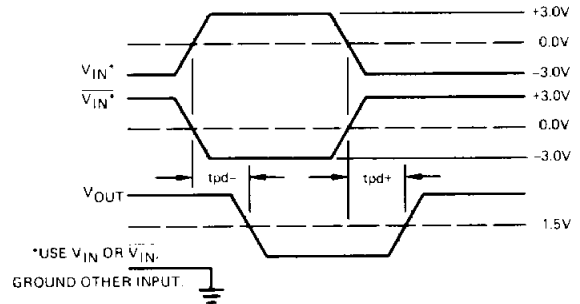
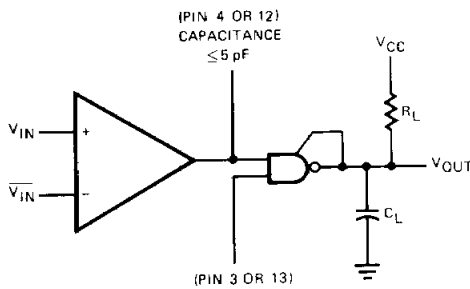

LIC-404

Figure 4

LIC-405

FREQUENCY RESPONSE CONTROL

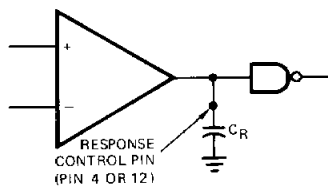

LIC-406

Frequency Response Versus Capacitance

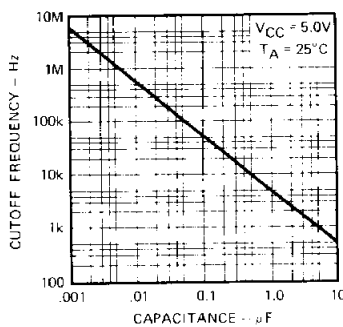

LIC-407

Am2615/9615 LOADING RULES

Input/Output	Pin No.'s	Input Unit Load	Fanout	
			Output HIGH	Output LOW
Out	1	—	o/c	10
Active Pull-Up	2	—	83	—
Response Control	3	—	—	—
Strobe	4	1.5	—	—
+ In	5	0.5	—	—
130 Ω	6	—	—	—
- In	7	0.5	—	—
GND	8	—	—	—
- In	9	0.5	—	—
130 Ω	10	—	—	—
+ In	11	0.5	—	—
Response Control	12	—	—	—
Strobe	13	1.5	—	—
Active Pull-Up	14	—	83	—
Out	15	—	o/c	10
VCC	16	—	—	—

Receiver A

Receiver B

**Am2615 STANDARD USAGE**  
**Single-Ended-Back Matched Operation**  
**With Common Ground**

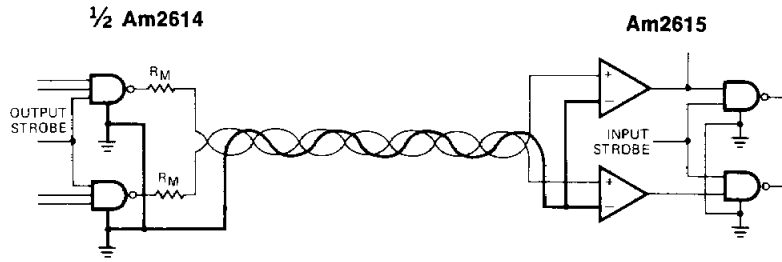

LIC-408

**Am9615 STANDARD USAGE**  
**Differential Operation**

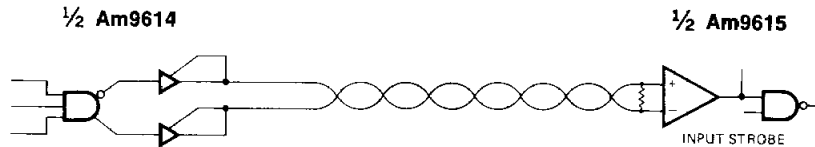

LIC-409

Photograph of an Am9615 switching differential data in the presence of high common mode noise.

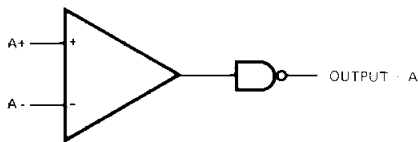

LIC-410

Vertical = 2.0 V/Div. Horizontal = 50 ns/Div.

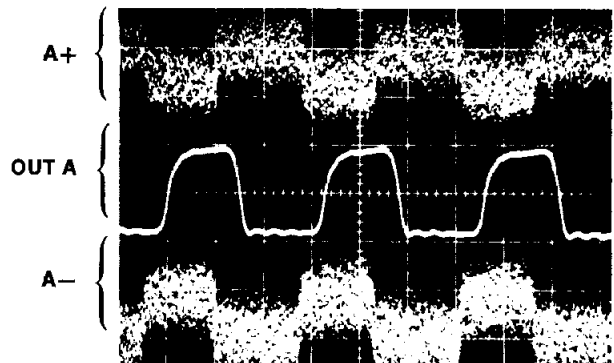

**Metallization and Pad Layout**

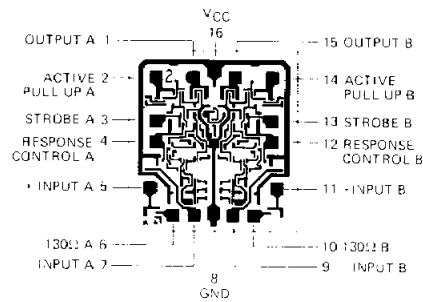

53 X 58 MILS